

Anakin Club Racer **ARF**

ENGLISH

ANAKIN
CLUB RACER



INTRODUCTION

CONGRATULATIONS on your purchase of a **SKY-HERO** Anakin Club Racer, we hope that it will provide you with many years of fun and entertainment.

SKY-HERO products are designed and developed in Belgium (Europe), but distributed and supported across the globe through a network of dealers and outlets that can provide assistance and advice.

OUR PHILOSOPHY

The **SKY-HERO** ethos is simple; provide cool, flexible, high quality aircraft, and back all products with a fair and reasonable support service

OUR CONCEPTS

FOLDABLE FRAMES FOR EASIER TRANSPORTATION	• PACKNGO
AERODYNAMIC DESIGN PROTECTING ELECTRONICS	• SLEEKNSEXY
HEAVY LIFT CAPABILITY WITH GREAT STABILITY	• LIFTNSTABLE
RACE BRED MODELS FOR COMPETITION EVENTS	• RACENWIN
CUSTOMISABLE AND UPGRADEABLE PLATFORMS	• EVOLVENGROW
LEAD THE COMPETITION THROUGH INNOVATION	• 1STEPAHEAD

SAFETY ADVICE

WARNING!

This aircraft is not a Toy!

All **SKY-HERO** aircraft can be considered as sophisticated leisure products, which require handling with care and caution in order to avoid injury to yourself or others. Ensure that you fully review all of the information in this instruction manual and familiarise yourself with the characteristics of this **SKY-HERO** aircraft before attempting to fly it

This instruction manual has been designed with safety in mind and is provided to help you assemble your aircraft and to prepare it for use. Assembly of this aircraft requires basic mechanical and electrical skills and flying this type of aircraft requires basic coordination skills and some practice..

GENERAL INSTRUCTIONS AND GUIDELINES FOR USE

- The aircraft should not be flown by children and definitely not by anyone under the age of 14.
- Failure to follow and comply with the safety advice and recommendations in this manual, can result in serious injury to you, others or property.
- You should always check the local laws and regulations of the country where you will operate the aircraft, to ensure you are in compliance with them. In particular you should avoid any sensitive areas such as Military establishments, Airports, Power stations and populated areas.
- Always keep an adequate safe distance around the aircraft, ensuring that you avoid proximity to buildings, people and anything which is outside of your control.
- The aircraft is controlled by radio signal which can be subject to interference outside of your control, a loss of radio contact with the aircraft puts it out of your control and could cause unpredictable results.
- Never fly the aircraft in confined or built up areas, where you might lose visibility of the aircraft.
- Never fly the aircraft in bad weather or strong winds, doing so could cause you to lose control with unpredictable results.
- Never approach the aircraft until the propellers have stopped turning and never try to touch it whilst it is in flight.
- Keep your batteries away from children, young children could attempt to put them in their mouth with dangerous consequences.
- Do not expose the aircraft to water, moisture or liquids.
- Do not attempt to fly the aircraft when battery power is low (including transmitter battery).
- Before each flight, make sure that all propellers are securely attached, that there is no damage to the aircraft or its electronics and wiring.
- Always disconnect the battery power to the aircraft before turning off the transmitter and always turn the transmitter on (checking the position of all controls) before connecting the battery.
- Always following the instructions provided with your Flight Controller and any accessory equipment such as transmitter, battery chargers etc.

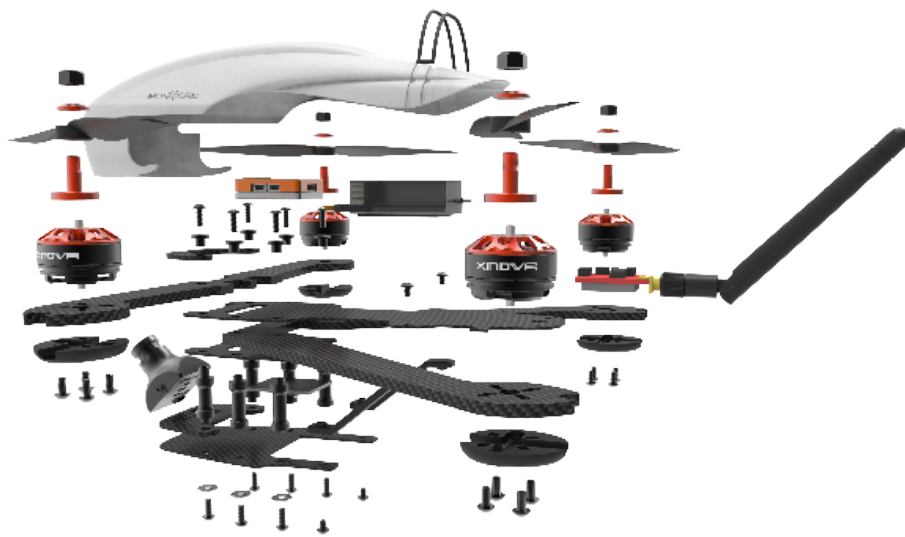



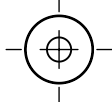
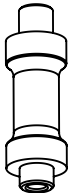
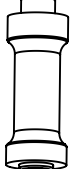

TABLE OF CONTENTS

PARTS LISTING	5
ADDITIONAL ITEMS REQUIRED TO COMPLETE	8
REQUIRED TOOLS AND EQUIPMENT	8
ASSEMBLY OF YOUR ANAKIN CLUB RACER	9
PDB CONNECTIONS	10
CAMERA SETUP	12
CHANGING YOUR VTX OUTPUT POWER	14
PAIRING YOUR SKY-HERO LINK9 RADIO AND TRANSMITTER	15
CC3D FLIGHT CONTROLLER SETUP USING OPEN PILOT GCS SOFTWARE	16
TRANSMITTER SETUP WIZARD	22
TESTING YOUR ANAKIN CLUB RACER	
ARMING PROCESS WORKS	25
TROUBLE SHOOTING	25
MANUALLY RE-CALIBRATING YOUR ESCS	26
ATTACH YOUR PROPELLERS	28
SELECTING YOUR FLIGHT MODE (SWITCH "C")	30
BEFORE YOU TAKE OFF	31
MOTOR ARMING AND TAKING OFF	31
USING ALTERNATIVE RADIOS & RECEIVERS	32
LIMITED WARRANTY	34

PARTS LISTING

	ISO7380 M3X14MM	2X	Screwset SKH07-112
	ISO7380 M3X10MM	24X	
	ISO7380 M3X6MM	8X	
	SELF TAPPING SCREW M3X6MM	4X	
	DIN 9021 WASHER M3	8X	
	SKH54-02-SCREW INSERT ANAKIN	6X	
	FRONT MAIN SPACER	2X	
	MIDDLE-REAR MAIN SPACER	4X	

Note: - screws 1/1 scale

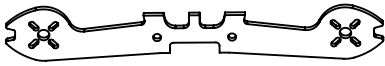

SKH03-215-F 5"

OR



SKH03-260-F 6"



SKH03-215-R 5" 2X

OR

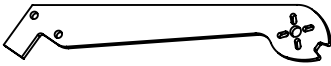

SKH03-260-R 6" 2X

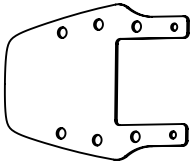

SKH03-201

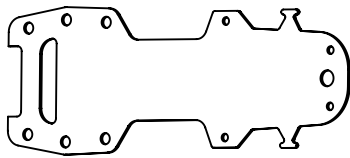

SKH03-201

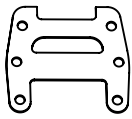

SKH03-201



SKH03-015



SKH03-015



SKH01-107 4X

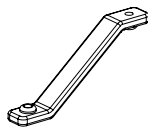

SKH01-104 2X



SKH05-024-01

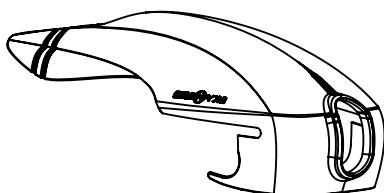

SKH05-026

ITEMS BELOW ONLY INCLUDED IN SKY-HERO ARF VERSION

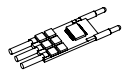

12-20A (2-4S) SKH04-025 4X



5"/215 = SKH04-028 4X

OR

6"/260 = SKH04-027 4X

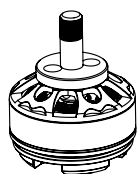

MOTOR 2204 5" = SKH04-023 4X

OR

MOTOR 2206 6" = SKH04-022 4X

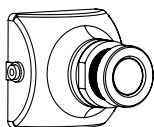

SONY 600TVL HS II 77 SKH04-026



PDB + 5V BEC SKH04-013

ADDITIONAL ITEMS REQUIRED TO COMPLETE

(with our recommendations)

Radio Transmitter & Receiver

- Link9 Mode 1 Radio & Receiver - SKH02-001-M1
- Link9 Mode 2 Radio & Receiver - SKH02-001

3-4S Lipo Battery and a Battery retaining strap

- Anakin Lipo 3S 1300mAh 35C - SKH08-012
- Anakin Lipo 3S 1300mAh 65C - SKH08-013
- LIPO 4S 1300mAh 65C - SKH08-014
- LIPO 4S 1800mAh 65C - SKH08-020 (6" Club Racer model only)

Video Transmitter (for camera and FPV use)

- VTX 25-600mW 40CH Race Band SKH04-015

REQUIRED TOOLS AND EQUIPMENT

- Soldering Iron
- Double sided adhesive Tape
- 2mm Hex Screwdriver
- 8mm Spanner
- 15mm Heat shrink Tubing (20 cm length)
- Male Futaba Servo type plug (with approximately 5cm of positive and negative wires connected)

The following instructions assume that you are using Sky-Hero components (Camera, VTX and Radio equipment), however towards the end of the manual there is also some basic information over the use of alternative equipment

If you are using the Sky-Hero supplied Camera, then we recommend that you either solder the Camera's black and red wires directly to the 5v filtered output of the PDB or you can remove the yellow cable from the Camera's Servo type connector then use the Camera's servo type connector to connect to the M6 port on the CC3D.

If you are using your own camera, you should choose an appropriate power source, based on the voltage and current requirements of your camera. If you use the Camera output from the PDB, check that the Lipo battery voltage is not higher than your camera's maximum input voltage.

NOTE: if you use a 4S Lipo and the FX795T-2 or FX795T-6 (200 / 600mW) VTX, we recommend to use a 12v Voltage Regulator between main board and VTX

ASSEMBLY OF YOUR ANAKIN CLUB RACER

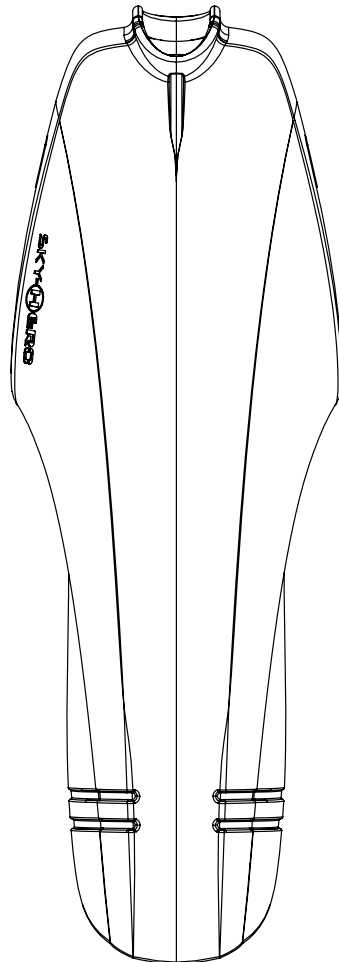
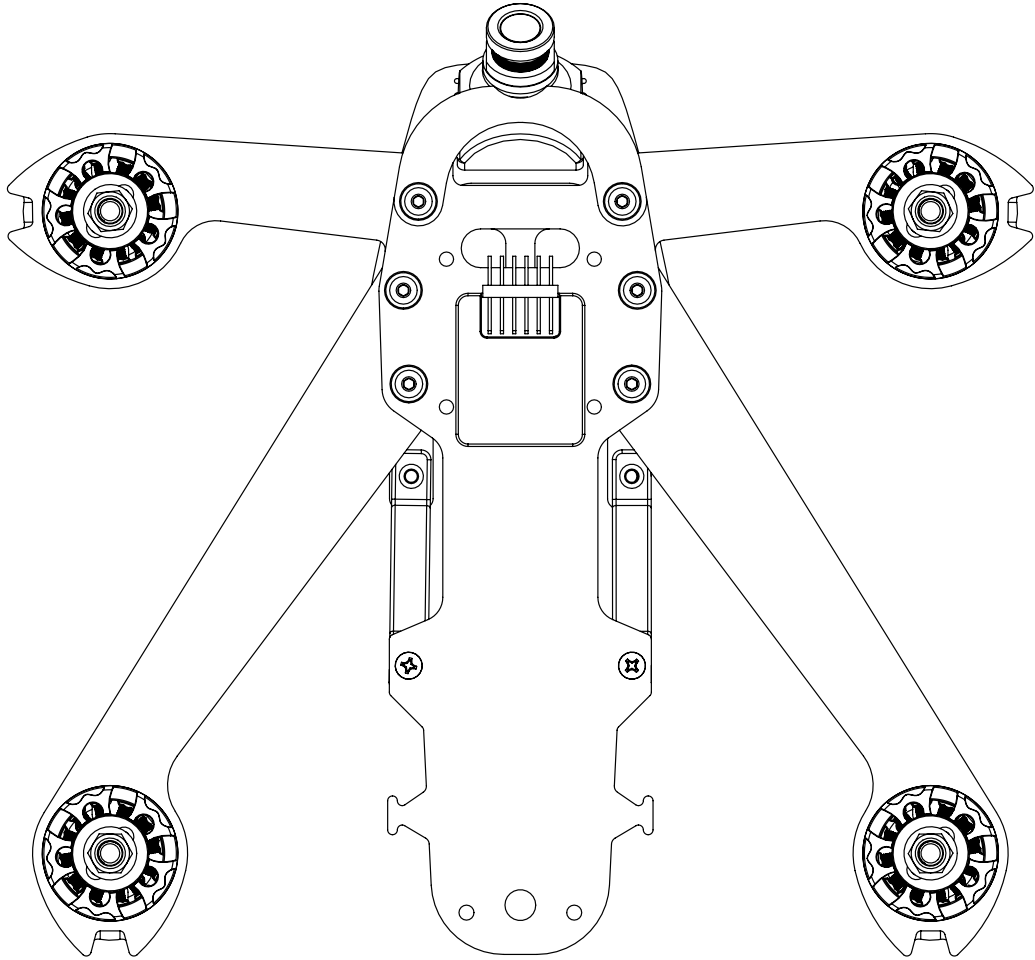

PDB CONNECTIONS

BATTERY CONNECTION
(2-4S)

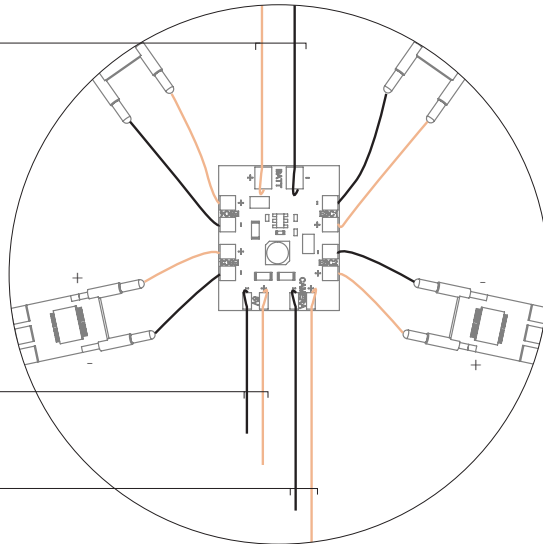

5V FILTERED OUT PUT
(SUITABLE FOR POWERING CC3D
FLIGHT CONTROLLER)

BATTERY VOLTAGE OUT (2-4S)
(SAME VOLTAGE AS BATTERY - MAY BE
SUITABLE TO POWER YOUR VTX,
CHECK YOUR VTX VOLTAGE REQUIREMENTS)

NOTE: the output labelled "Camera" provides the same voltage as your battery input. The 5v output is filtered and can support up to 3 Amps

Plug the camera cable into the rear of the camera
(taking note that the Camera's plug socket should be at the top of the aircraft)

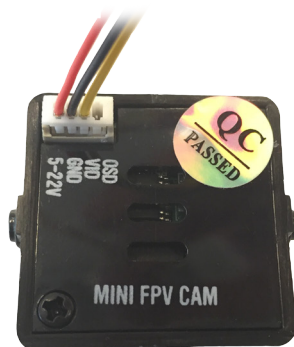

use a small knife or something similar to remove the yellow video out cable from the Camera's black Servo type plug

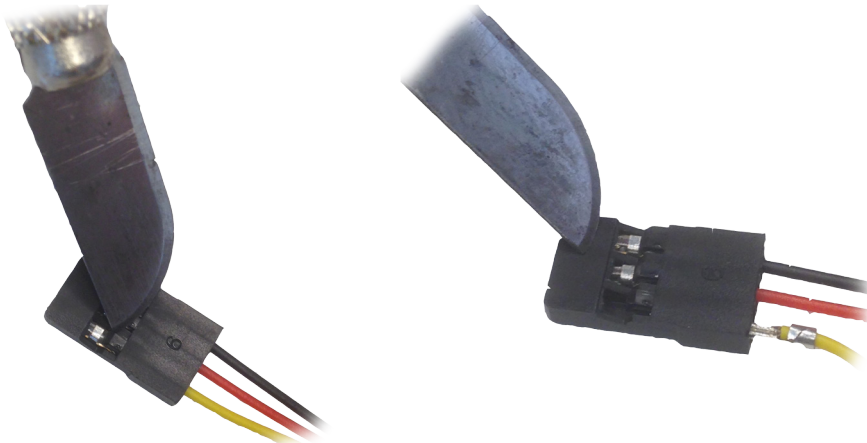

Pass the 3 cables up from lower part of the frame to the top of the frame.

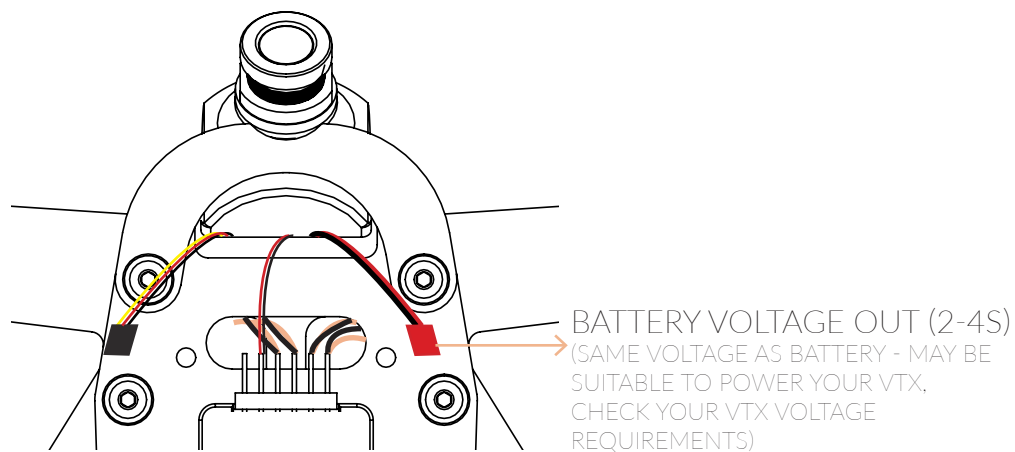

The Yellow video out cable can then be soldered or connected to the VTX video input cable. If you are using the Sky-Hero VTX, and you do not want to do any soldering, you can cover the connector from the camera in heat shrink tubing and insert it into the VTX connector (connecting to the yellow wire pin)



Connect the Camera's "Power in" connector to the CC3D M6 port, ensuring that the black wire is at the bottom

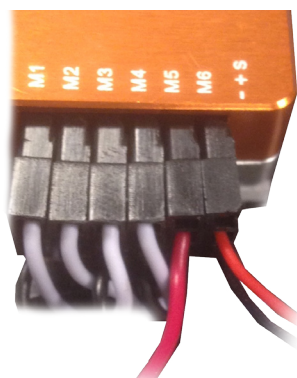

CAMERA SETUP

In order to make fine adjustments to your camera angle, it may be necessary to slightly ream out (deepen the size of) the grooves in the adjustable lower camera plate (this can be done using a small file or drill)

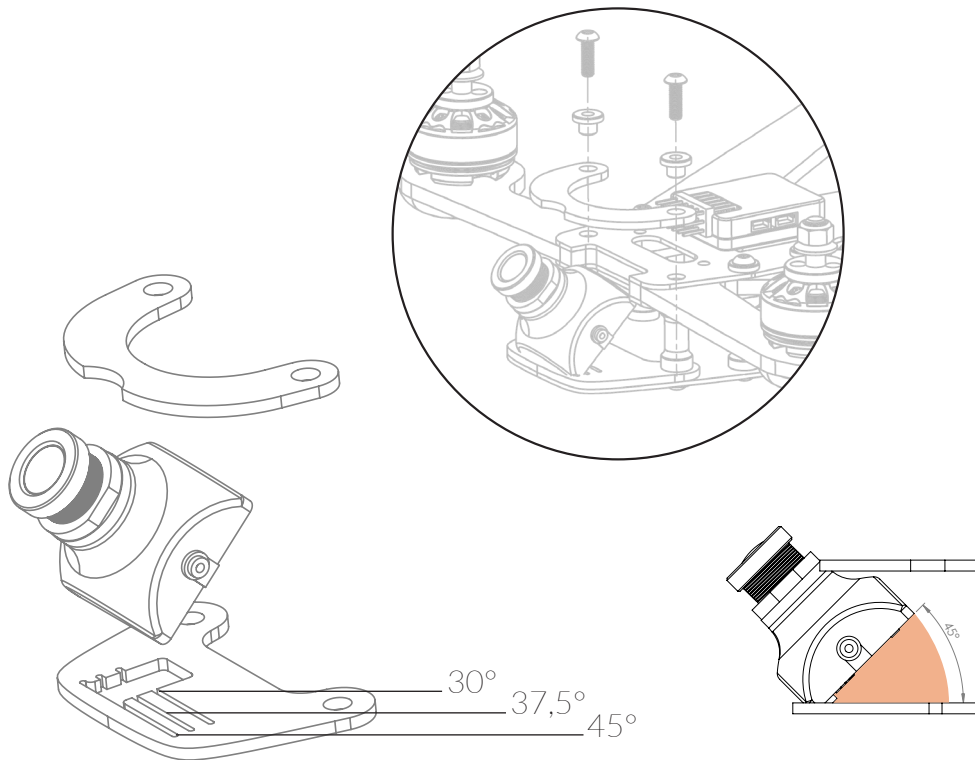

NOTE: You can remove the camera at any point to adjust its position by slightly unscrewing the two bolts holding the curved bracket above the camera

Using double sided adhesive tape, position the CC3D flight controller in the middle of the upper frame and 10mm back from the edge of the 2nd hole in the upper frame and connect the 4 wire (Black, Red, Blue and Yellow) CC3D cable to the "Main Port" of the CC3D

NOTE: with the CC3D label facing upwards the black wire of the connector should be on the left side of the main port as you push it in.

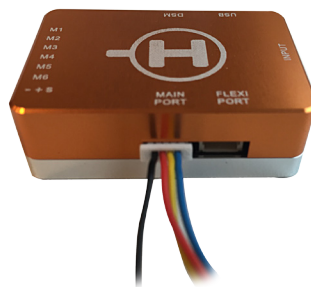

Next step is to use double sided adhesive tape to position the Link9 Radio Receiver behind the CC3D Flight Controller as shown in diagram below.

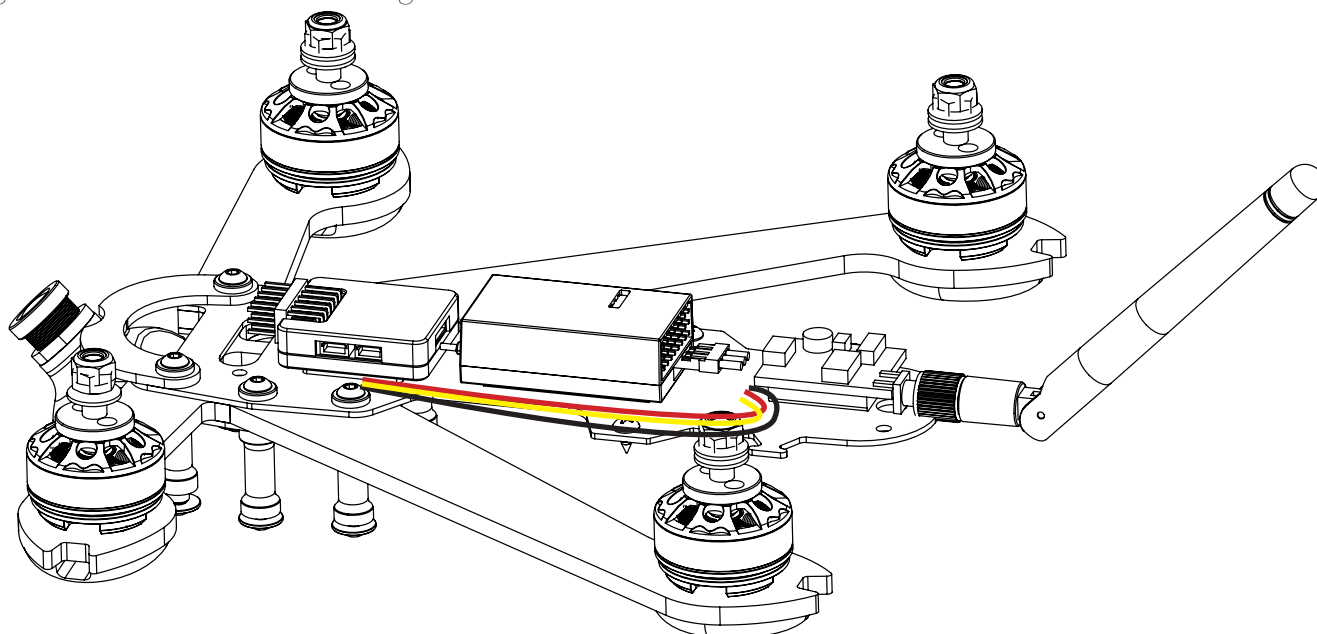

The SBus Port is horizontal port in bottom right corner of the image below and left to right the pins are; signal, positive and negative.

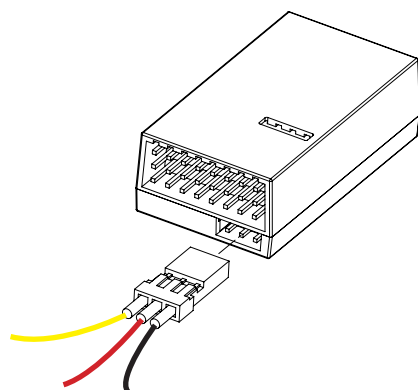

Connect the Black, Red and Yellow wires from the CC3D "Main Port" to the SBus port of the Receiver, in the sequence shown above (Yellow = Signal, Red = Positive, Black = Negative)
Now you should fix the VTX in place (as shown below) using double sided adhesive tape

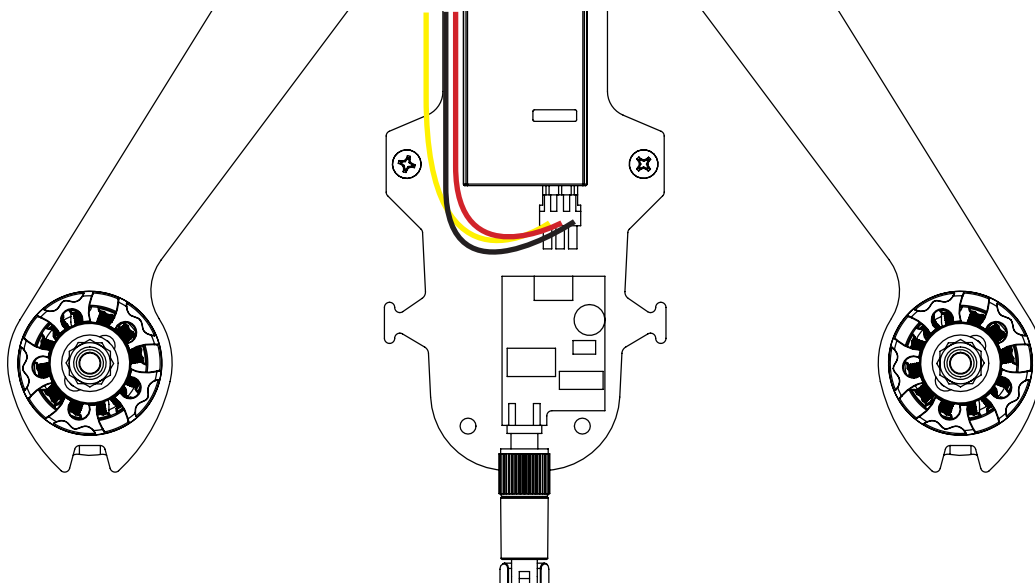

To avoid potential damage to your VTX you should attach the antenna to it now, because if you connect power to the VTX without the antenna in place – the VTX can be permanently damaged. With the antenna in place, connect the VTX Power lead to the red plug at the front of the Anakin Club Racer.

CHANGING YOUR VTX OUTPUT POWER FROM 25mW – 200mW

The Sky-Hero VTX is cable of operating in 2 power modes, either 25mW or 200mW. By default the output power is set to 25mW, but to increase it to 200mW you need to cut the small wire shown in the 2 images below. (To reset it to 25mW simply reconnect/resolder the wire)

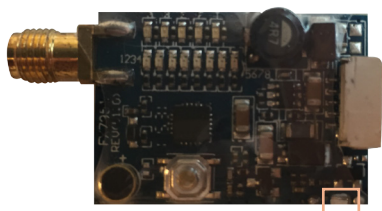

Changing the VTX channel is done by pressing on the small button. If you press and hold the button for a couple of seconds it changes the VTX Band (A-E).

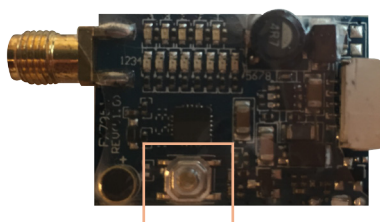

NOTE: if you use a 4S Lipo and the FX795T-2 or FX795T-6 (200 / 600mW) VTX, we recommend to use a 12v Voltage Regulator between main board and VTX

The choice of channel frequencies is shown in the table below

FR	CH	CHANNEL							
		CH1	CH2	CH3	CH4	CH5	CH6	CH7	CH8
FR	FR1(A)	5740	5760	5780	5800	5820	5840	5860	5880
	FR2(B)	5705	5685	5665	5645	5885	5905	5925	5945
	FR3(C)	5865	5845	5825	5805	5785	5765	5745	5725
	FR4(D)	5658	5695	5732	5769	5806	5843	5880	5917
	FR5(E)	5733	5752	5771	5790	5809	5828	5847	5866

NOTE: Remember you must never connect your Lipo battery if the VTX antenna is not connected.

PAIRING YOUR SKY-HERO LINK9 RADIO AND TRANSMITTER

Ensure that you have removed your propellers and that your VTX antenna is in place. Switch on your Link9 Radio (if you already have another aircraft setup on your Radio, you may need to select a new model within the Transmitter menu).

Connect a 3-4S battery to the Club Racer and wait about 5 seconds then press the Bind button on the side of the Link9 Radio Receiver and hold it in for a couple of seconds until its LED starts to flash rapidly



When it stops flashing, it is bound with your Transmitter and on the radio Transmitter screen you will see that the signal strength is now indicated with a number of bars



If the Receiver LED is showing RED, then Push the bind button twice (in quick succession) and the Receiver LED will blink temporarily before changing to a solid, combined pink+blue “purple” colour, meaning that the receiver is now correctly configured in SBus mode. You can now disconnect your battery

CC3D FLIGHT CONTROLLER SETUP USING OPEN PILOT GCS SOFTWARE

WARNING! Make sure you have removed your propellers before starting this section!

This instruction is for setting up the CC3D flight controller that comes with your Club Racer ARF with the Link9 Radio/Receiver and using the OpenPilot GCS software for the Microsoft Windows platform. If you are not using the Sky-Hero Link 9 radio with its receiver go to the section «USING ALTERNATIVE RADIOS & RECEIVERS»

Ensure that you downloaded and installed a copy of the OpenPilot GCS v15.05.02 software
Ensure your Lipo battery is NOT connected at this point and that the OpenPilot software is NOT running on your computer.
Connect your Micro USB Cable to the CC3D “USB” port and the other end to your computer.

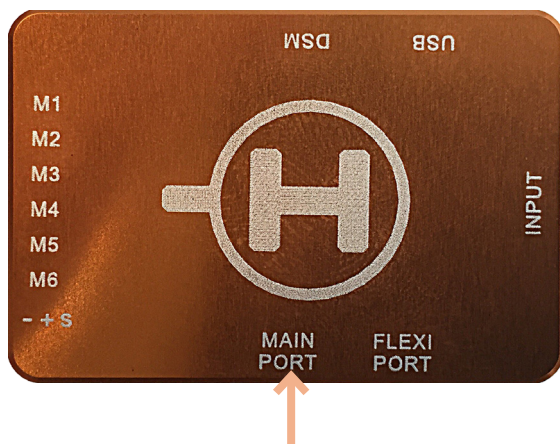

You may have to wait up to a couple of minutes for your computer to recognise the CC3D device (and in some cases install the necessary driver). If you want to check that the CC3D device has been recognised by your computer, you can look in Windows Control Panel under Devices and you should see a “CopterControl Virtual COM Port” listed under the “Ports” category (Note: the COMxx number will generally change each time you connect the CC3D)

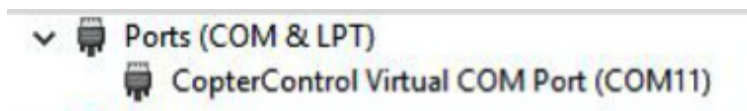

Normally the light on the CC3D will flash very fast initially, then it will start flashing slower. Once it is flashing slower it is ok to start the software

1. Open the OpenPilot software and if you see a pop up message warning the GCS does not match your firmware, click “Ok”

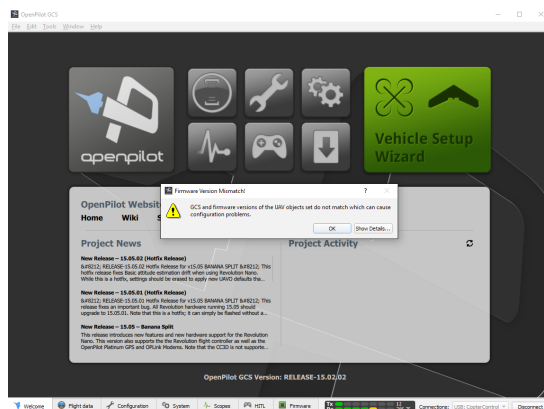

2. Click the Vehicle Setup Wizard



3. On the Vehicle Setup Wizard welcome screen, Click Next

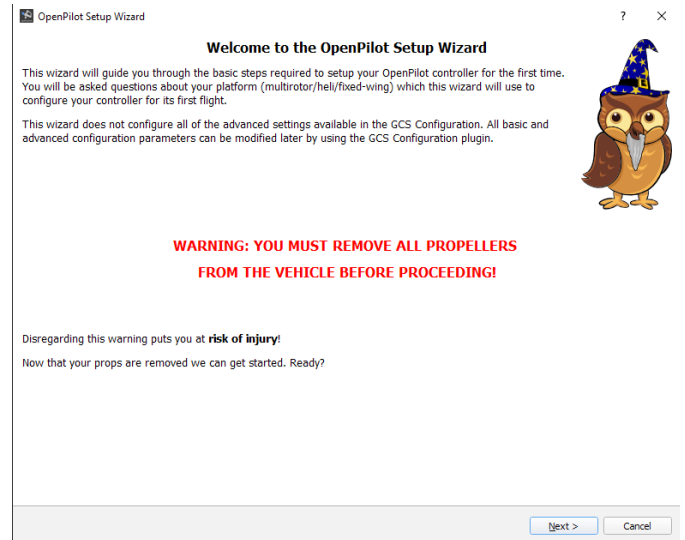

4. On the Firmware update screen, **remove the tick** from "Erase all settings" option and Click the "Upgrade" button



5. When the upgrade is finished, click Next

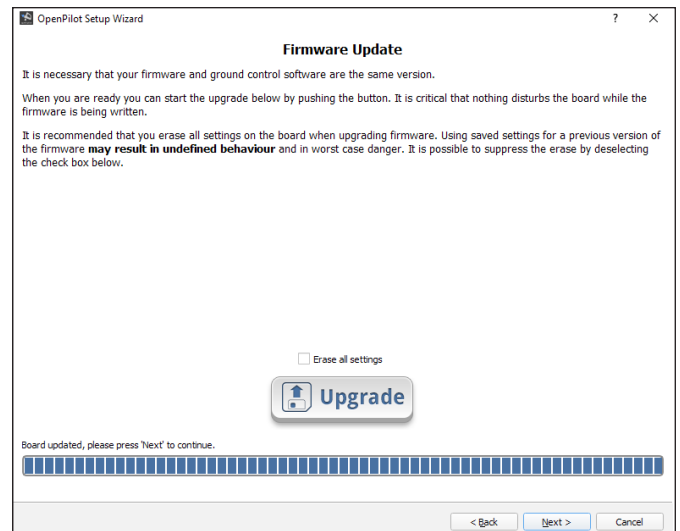

NOTE: if the CC3D controller does not reconnect automatically after the upgrade, close the OpenPilot software, remove the usb cable from your computer, reinsert the usb cable – wait for a couple of minutes and restart the OpenPilot software

6. On the Board Identification screen, Click Next

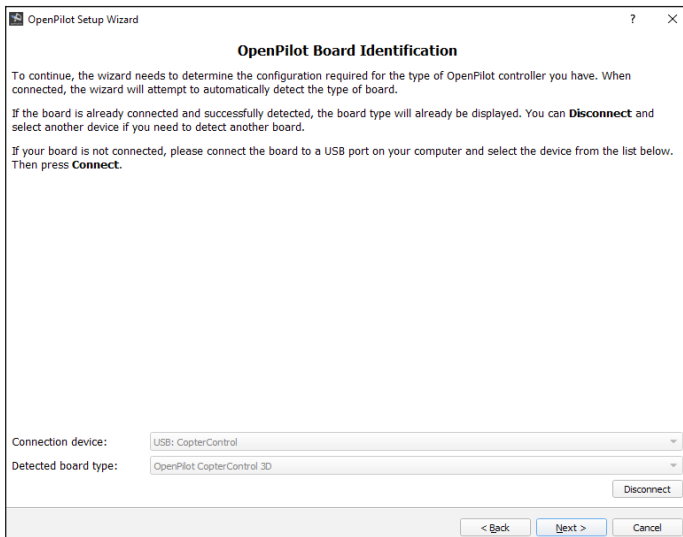

7. On the Input signal configuration screen, Select the SBus Option and Click Next

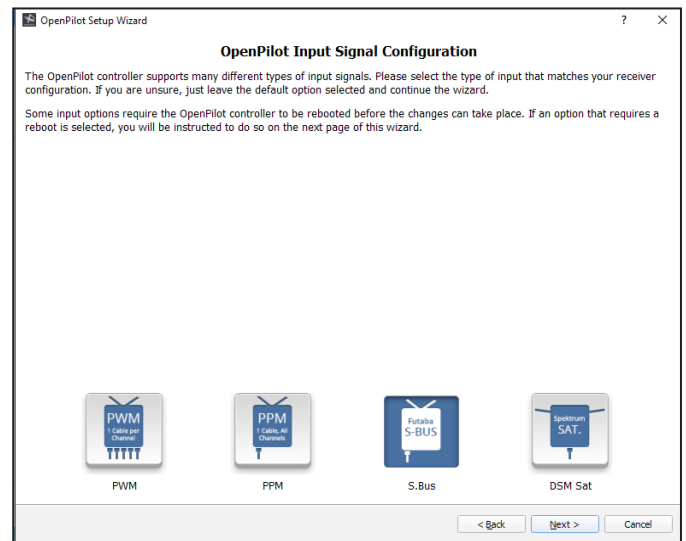

8. On the Vehicle type selection screen, ensure that "Multirotor" is selected and Click Next

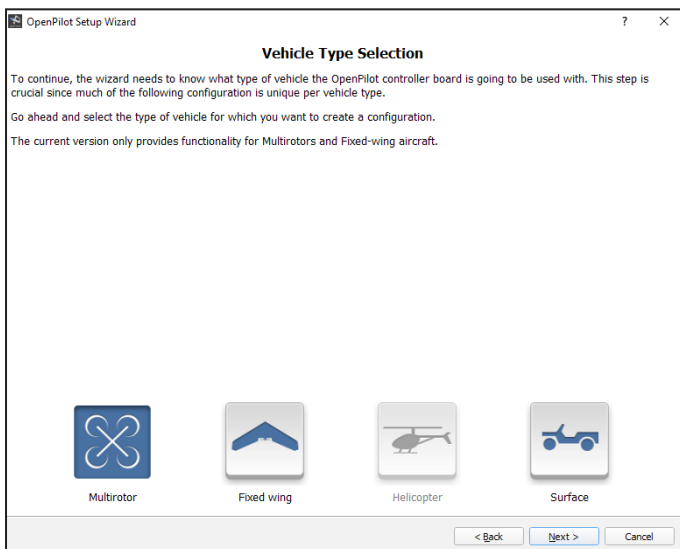

9. On the Multirotor configuration screen, ensure that "Quadcopter X" is selected and click Next

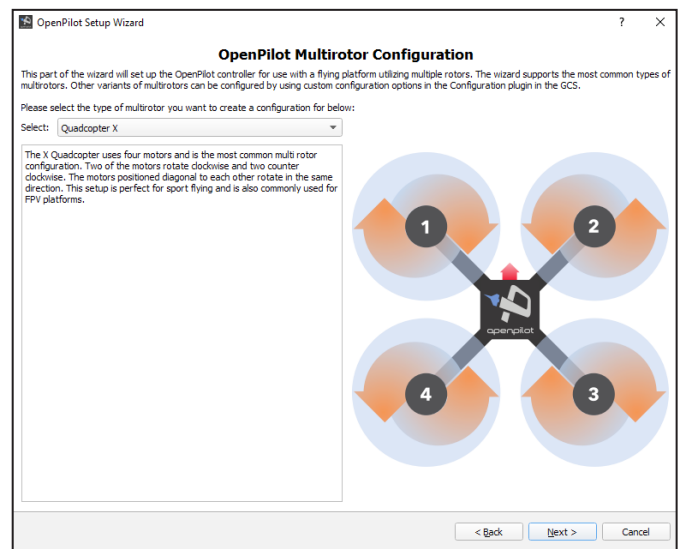

10. On the Output signal configuration screen, ensure that "Oneshot 125" is selected and Click Next



11. On the Configuration summary screen, Click Next

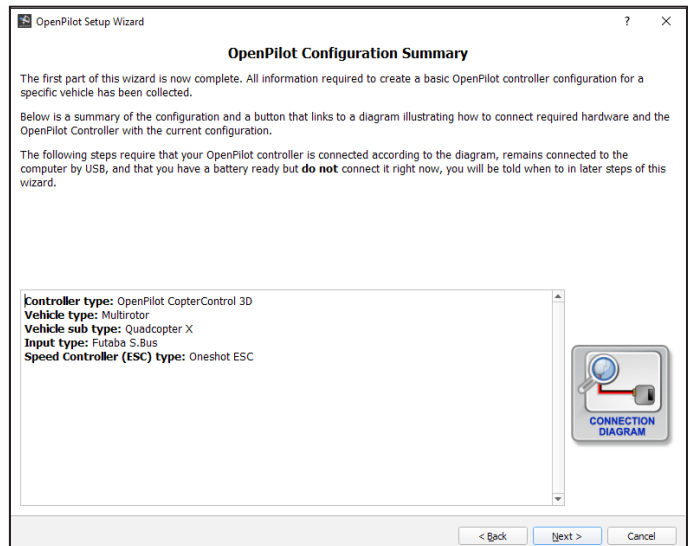

12. On the Sensor Calibration Procedure Screen, ensure that the CC3D is on a flat level surface, where it will not be subject to any movement or vibration, then Click “Calculate” (and ensure the CC3D is not moved until the calibration process is completed), then Click Next

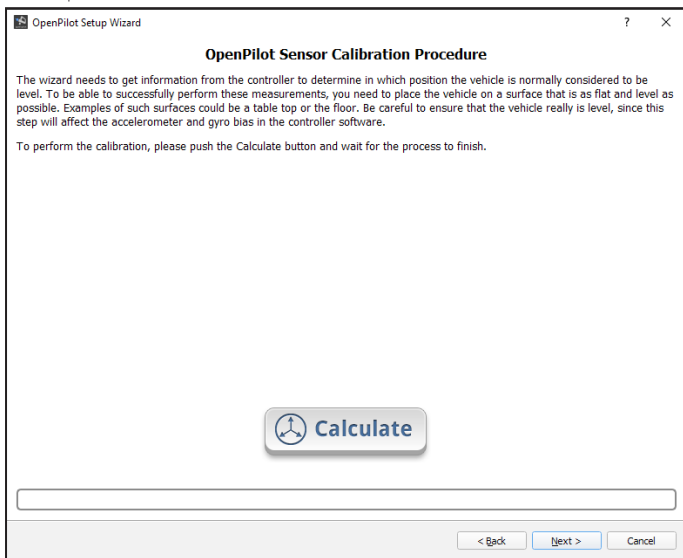

13. On the ESC Calibration Procedure Screen, double check that your battery is not connected and no propellers are attached, then tick the 3 boxes and Click Start

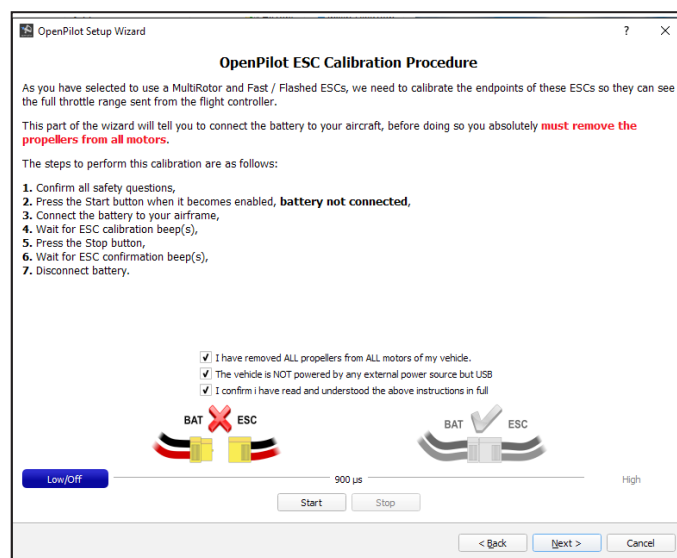

14. When the screen changes (as shown below) connect your battery, wait for the multi-tone calibration beeps, then Click the “Stop” button

Wait for more multi-tone beeps, then you can disconnect your battery and Click Next

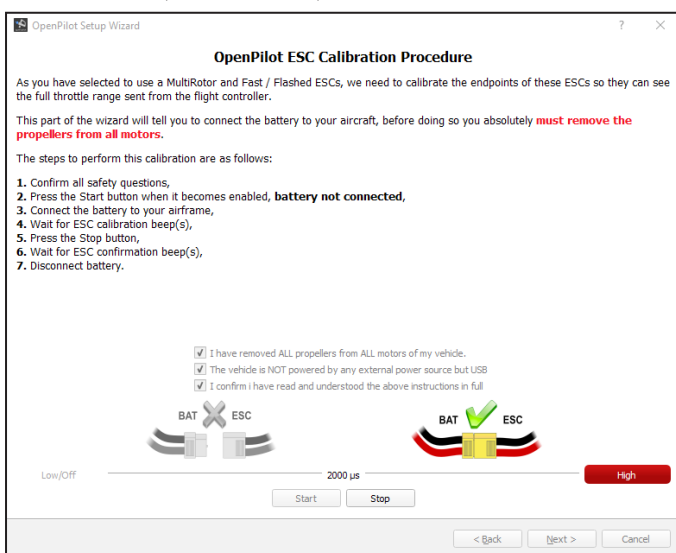

In the next step we will apply power to spin the motors, so ensure that your motors are clear of anything that could get wrapped around them or cause a danger to yourself. Make sure your propellers are not installed.

15. On the Output Calibration Screen, Click Next and connect your Lipo battery

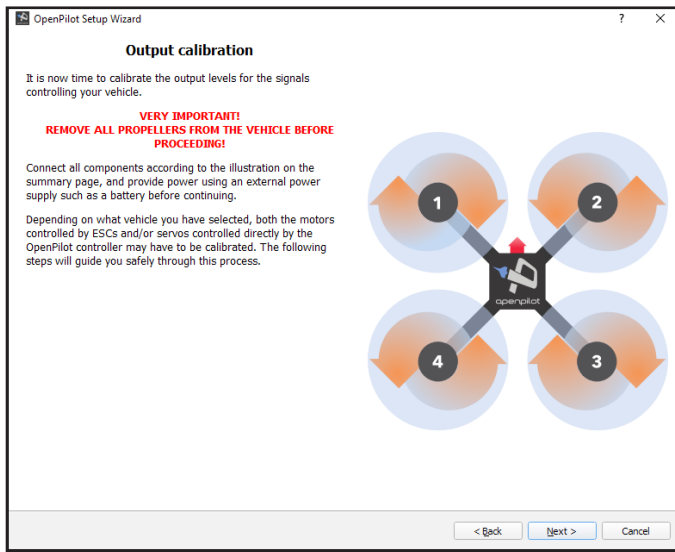

16. To find the neutral rate (slowest smooth rotation speed) of each motor, Click "Start" and then move the slider to the right until the motor starts to turn, adjust the slider left or right until you reach the slowest speed at which the motor's rotation is smooth and constant.

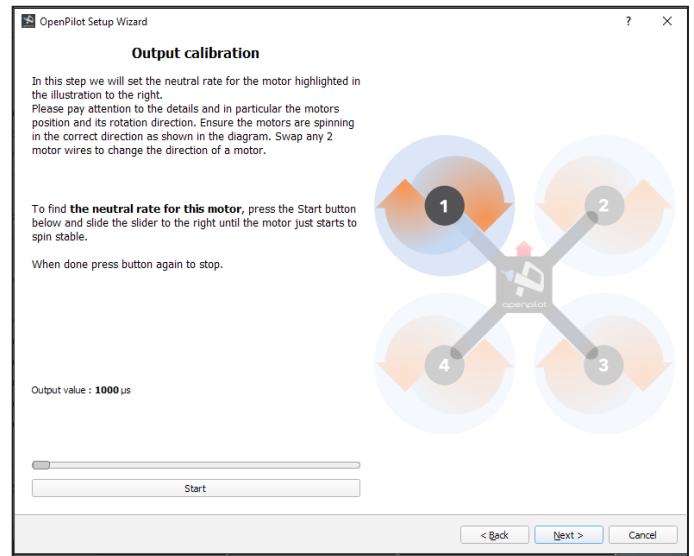

17. Click Stop. Once the first motor is calibrated, click "Next", then do the same procedure for the three other motors. Click "Next" to continue. Disconnect the battery.

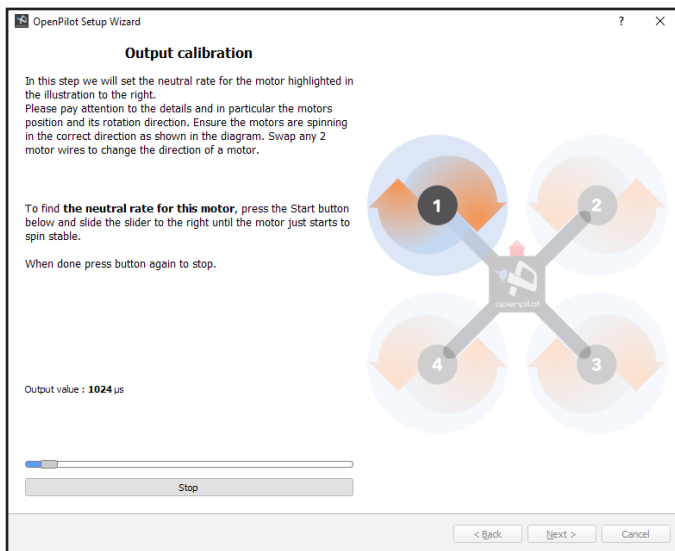

18. On the Initial Tuning screen, Click Next

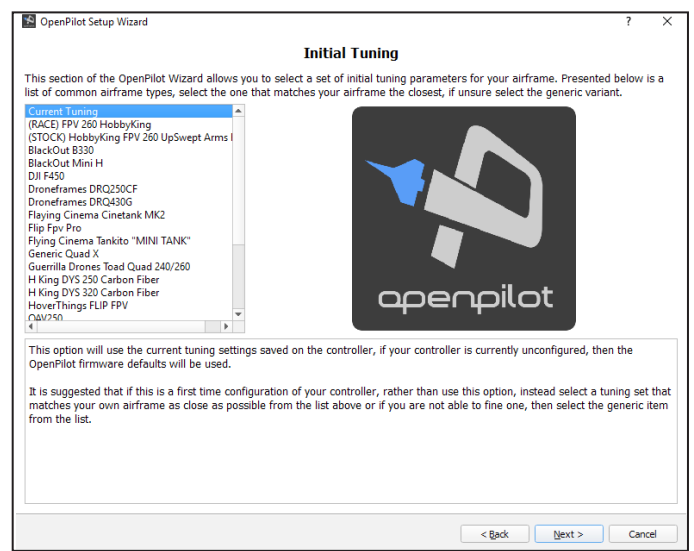

19. On the Configuration ready to save screen, Click Save, then Click Finish.



TRANSMITTER SETUP WIZARD

Now it's time to calibrate the radio. Turn your radio transmitter on, ensure that you do not have your propellers attached to the Anakin Club Racer and then connect the Lipo Battery.

- If your computer is still connected via the usb lead to the CC3D then go to step 2 below

- If your micro usb lead is not already connected between the CC3D's usb port and your computer – you should ensure that the Open Pilot software is not running, and then re-connect it the usb lead. Wait a couple of minutes for the CC3D board to be recognised then re-open the Open Pilot software. Go to step 1 below.

Wait a couple of minutes for the CC3D board to be recognised (the light on the CC3D stops flashing rapidly), then re-open

1. On the configuration tab (bottom of OpenPilot Screen), click the “Input” tab on the left and then click on “Start Transmitter Setup Wizard”

2. On the following screen, Click Next

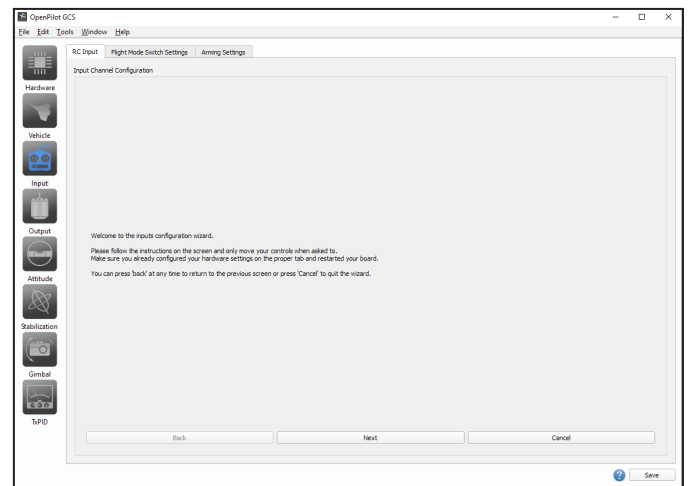
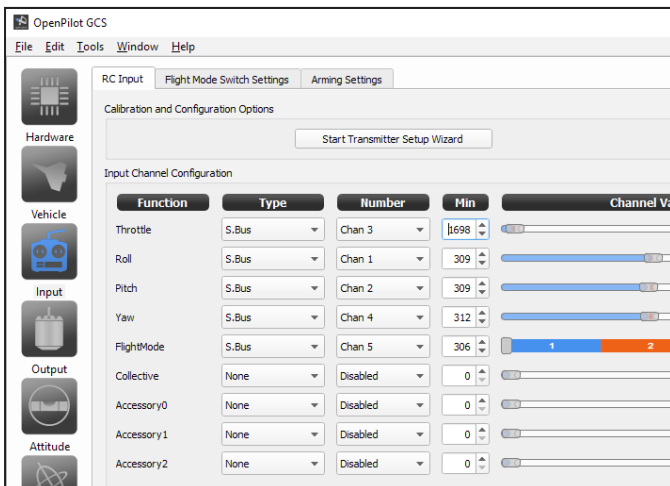

3. On the Transmitter Type screen, ensure that “Acro” is selected and Click Next

4. On the Transmitter Mode Screen, Select the Mode related to your Transmitter setup (in this example we have selected “Mode 2”), Click Next

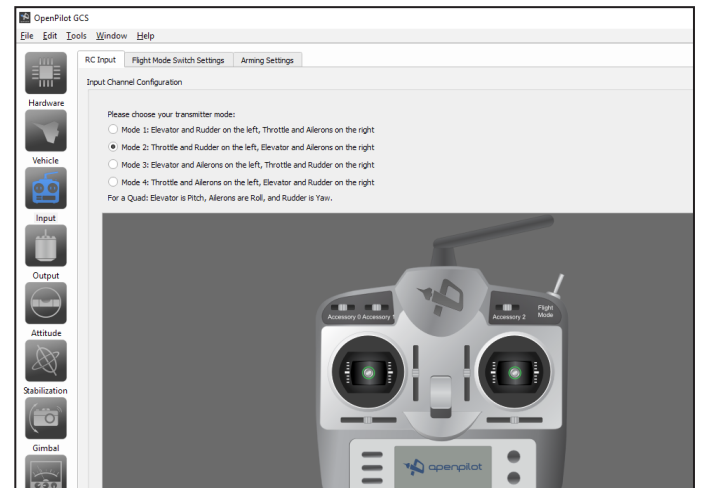
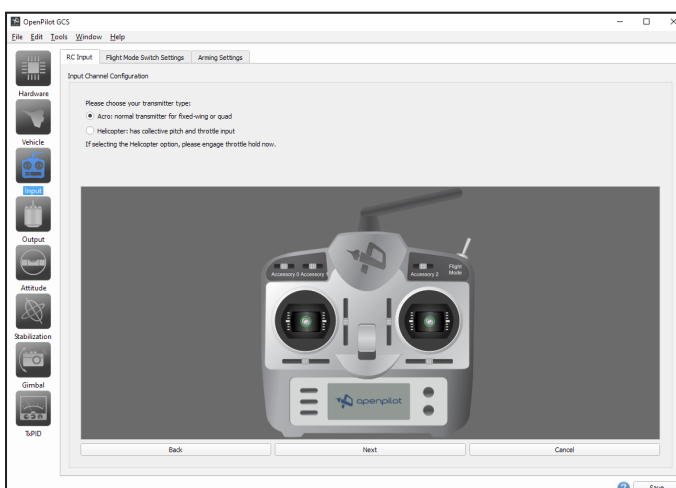

5. On the Input Channel Configuration Screen, follow the instructions to configure the controls:
 Move the Throttle stick up or down as shown in the Open Pilot screen
 Move the Roll stick left or right as shown
 Move the Pitch stick up or down as shown
 Move the Rudder stick left or right
 Move switch C fully up and down a couple of times to configure the Flight Mode Switch
 For the Accessory0,1 and 2 switches, just click Next 3 times (no need to move any switches on your Transmitter, unless you plan to configure a CC3D function on one of these switches)

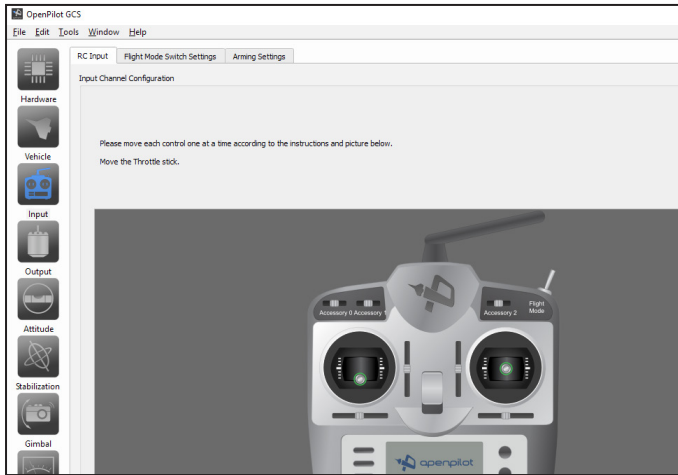

6. Now you need to move the 2 flight control sticks to their maximum position in all directions (including all corner positions), when you have finished – Click Next

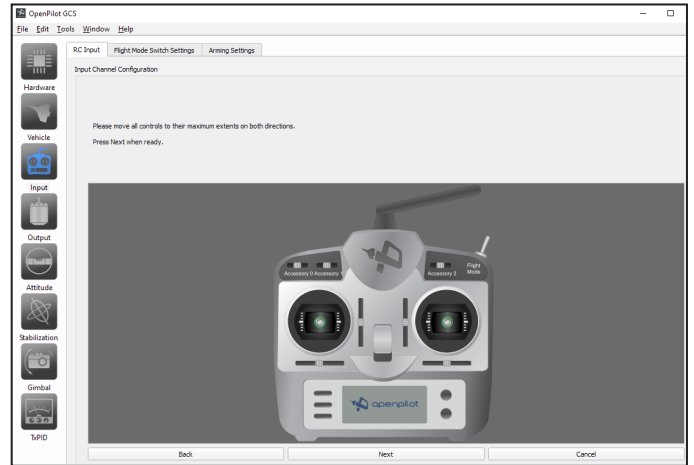

7. Now you need to verify that when you move a control on the Transmitter, the exact same movement is reflected on screen. (if any movements are in acting in reverse, tick the appropriate box to correct it). When all movements are working correctly, Click Next

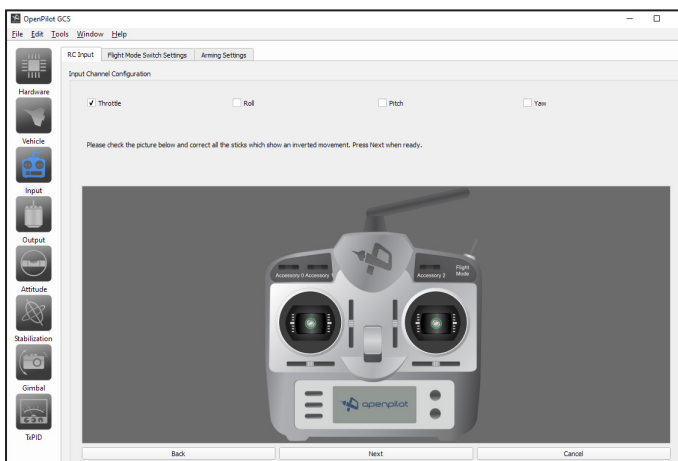

8. When the screen below appears, center your control sticks, then Click Next

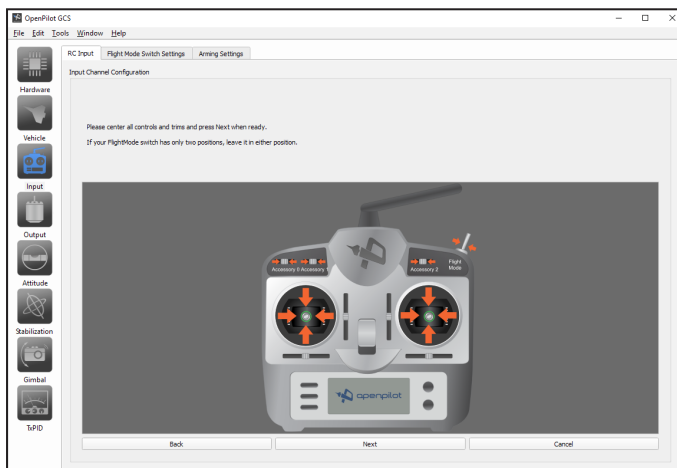

9. The final step in the Wizard process is to click on the Arming Settings Tab at the top of the screen and decide on the method you would like to use "Arm" the Club Racer.

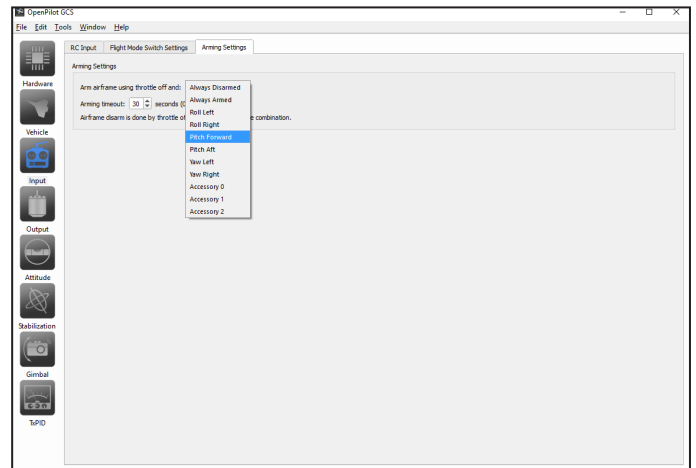

The Arming process is designed to help avoid that your Club Racer's motors start turning by accident.

NOTE: the Throttle stick must always be at its lowest position in order for the arming process to work. In the previous screen shot "Pitch Forward" has been chosen as the arming method, this means that if your Transmitter is configured for Mode 2 use, then you must have the left stick in its lowest position and you push forward on the right stick for a few seconds.

You can also choose how long the Club Racer remains "Armed" by changing the "Arming Timeout" value from its default value of 30 seconds (make sure that you Save your settings if you change this value)

10. Click the "Attitude" tab on the left of the OpenPilot Screen, and make sure you put "180" into the "Roll" setting. Then Click the Save button.

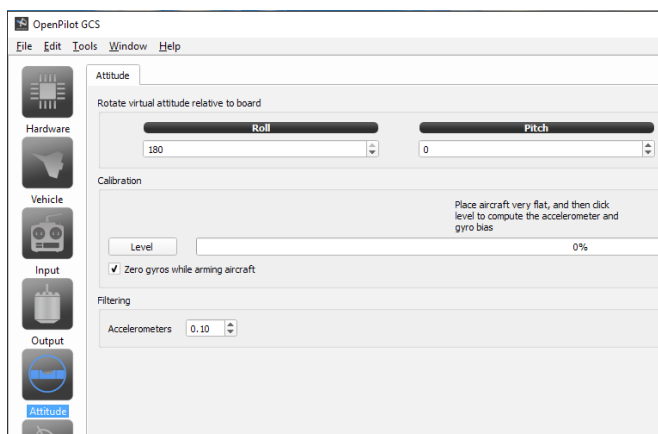

11. Click on the Input tab on the left and adjust the "Min", "Neutral" and Max values for "Chan 5" to match the screen below. Then Click the Save button

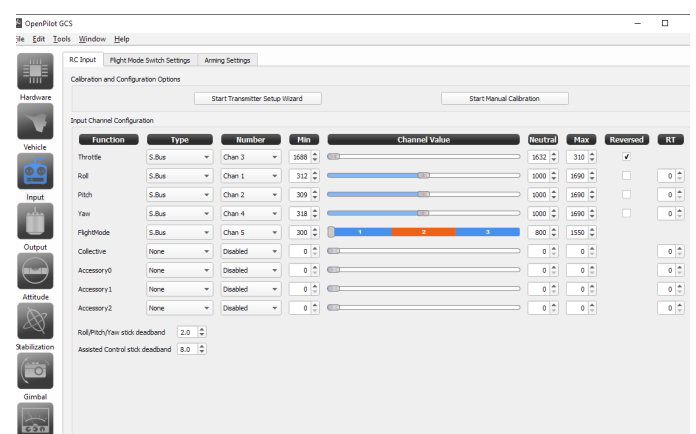

The change in step 10 above, is very important and failing to do so, will make your Anakin Club Racer impossible to fly as the controls will appear to operate in reverse. (In order to have optimal cable connections, the CC3D is actually mounted in reverse with its front pointing to the rear)

PLEASE DO NOT MODIFY THESE CC3D SETTINGS UNLESS YOU ARE FAMILIAR WITH CC3D TUNING AND YOU FULLY UNDERSTAND WHAT YOU ARE DOING. MISCONFIGURATION OF THE CC3D CONTROLLER MAY CAUSE HARDWARE ISSUES WHICH CAN NOT BE REPAIRED BY THE END USER AND WOULD ALSO VOID YOUR SKY-HERO WARRANTY

Exit (close down) the Open Pilot Software (If prompted to Save your configuration, then Click the Save button). Disconnect the battery from your Anakin Club Racer, disconnect the USB cable from the CC3D and your switch off your Radio Transmitter

TESTING YOUR ANAKIN CLUB RACER ARMING PROCESS WORKS

Ensure that your propellers are not yet connected to your Anakin Club Racer, Insert your Battery into the battery bay and secure tightly with a strap. Turn on your Radio Transmitter. Make sure that your Anakin Club Racer is in a safe position with nothing close by that could be damaged when you start the motors. Ensure that your throttle stick is in the lowest position, Connect the Anakin Club Racer battery, then push the stick, ensure that your throttle stick is in the lowest position and then push the stick which you have configured earlier to arm your Anakin Club Racer.

TROUBLE SHOOTING

If your Anakin Club Racer will not respond to your "Arming" start sequence, then you should re-connect the usb cable, restart the OpenPilot software and check that on the Configuration -> Input -> Arming Settings screen, a valid option has been selected and click the Save button.

If you find that any motors are "twitching" or turning when you have not yet initiated your Arming sequence, this could indicate one of several things:

1. ESC has not been properly calibrated during the OpenPilot calibration process
(see "Manually re-calibrating your ESCs" below)
2. Faulty motor (try replacing the motor)
3. Faulty ESC (try replacing the ESC)
4. Bad soldering connection between your motor and its ESC or ESC and PDB
(resolder the connections)
5. Motor mount screws are too long and have been screwed too far into the base of your motors
(use correct length screws with a new motor)

MANUALLY RE-CALIBRATING YOUR ESCS

1. Ensure that propellers are not attached and that your Anakin Club Racer is in a safe position where spinning the motors will not cause any danger

2. Ensure that the OpenPilot software is not running on your computer, connect the USB cable between the CC3D and your computer, wait a few moments for your computer to recognise the connection and then open the OpenPilot software. Make sure that your battery is not connected at this point

In the OpenPilot software Select the Configuration Tab at the bottom of the screen, then click on “OutPut” on the left

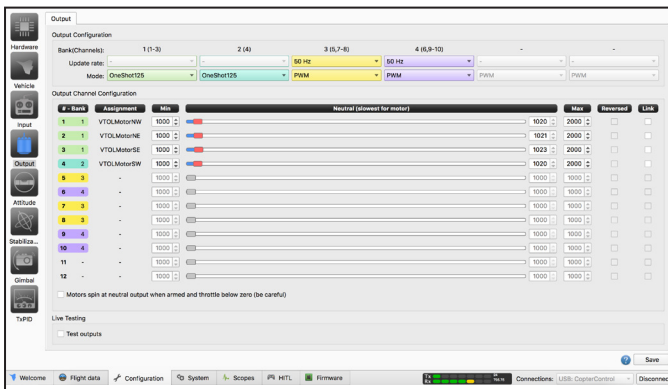

3. Use the diagram below to identify which motor/ ESCs are not working correctly

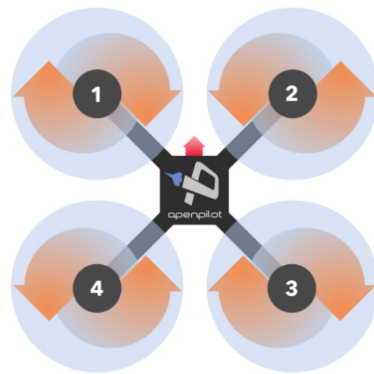

4. For the 1st of the motors you have identified, in OpenPilot move the Red slider for that channel to the rightmost position

- In the example screen below, we assume that motors/ ESCs 1 is not working correctly and the screen shows the associated change to the OpenPilot screen

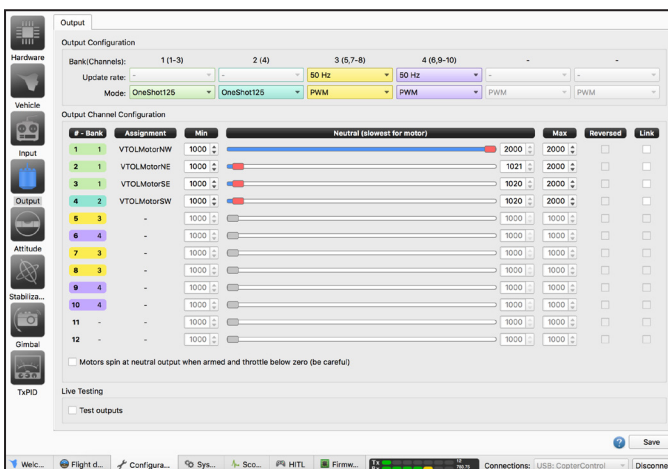

5. Click the “Test Outputs” box at the bottom left of the screen (to put a tick in it) and acknowledge the warning message

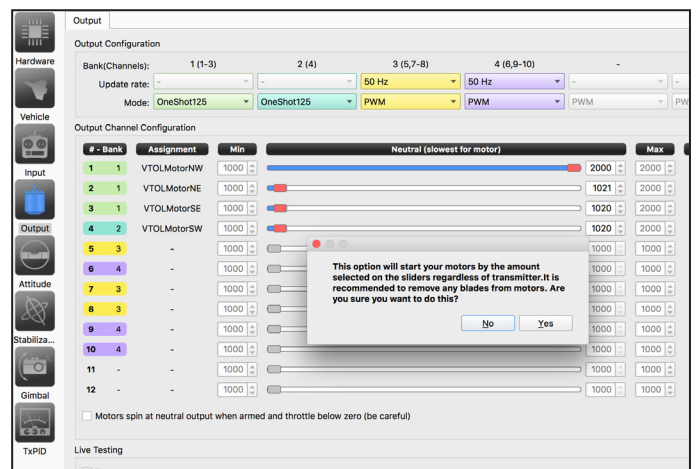

6. Connect your battery. It is possible that some motors will start spinning (this is ok) You will hear several initialisation tones from the motor you are correcting, when these stop – press the “Home” button on your keyboard (Fn + left arrow on MAC computer). This will move the red slider to the leftmost position

7. Click the “Test Outputs” box (to remove the tick from it) and acknowledge the message about saving neutral settings.

Remove the battery, Click the Save button and then re-connect the battery

Click the “Test Outputs” box (to put the tick back in it) and once again acknowledge the message about saving neutral settings.

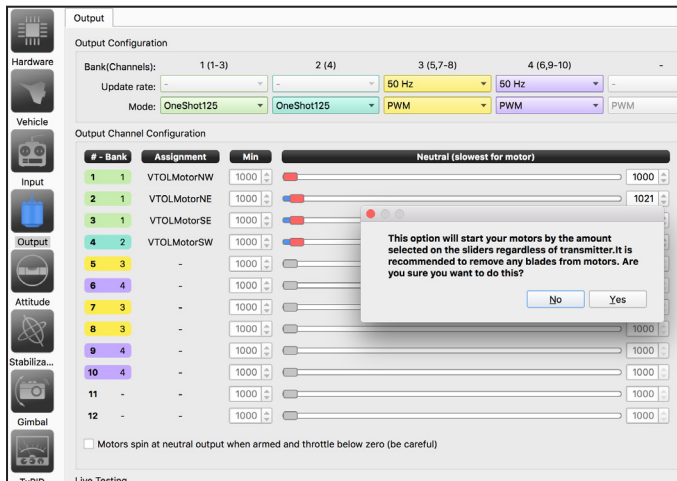

8. Several motors will probably now start turning, but you need to adjust the slider for the 1st motor until it is turning at the lowest, smooth and constant rate

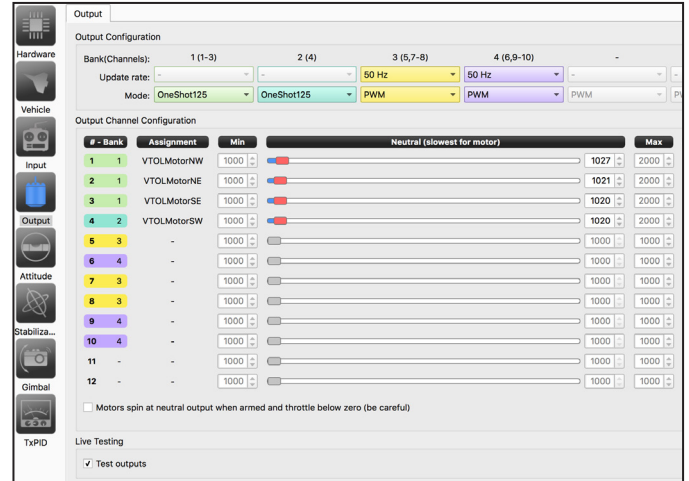

9. Remove the tick out of Test Outputs (all motors will stop)

Acknowledge the message about saving your Neutral settings and Click Save

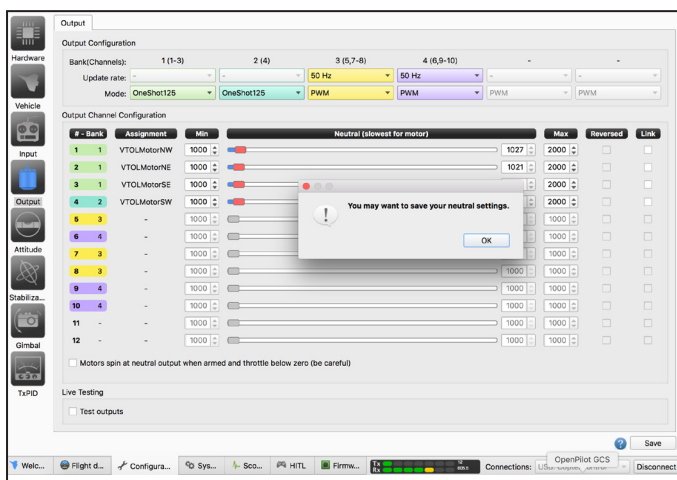

10. Now return to Step 3. Above and repeat all steps in the process up to this point (for any other motors which are not working correctly)

Once all motors are working correctly. Disconnect your battery, Ensure that you have removed the Tick from “Test outputs” and Click Save

Exit the OpenPilot Software, Disconnect your USB lead and continue.

ATTACH YOUR PROPELLERS

Complete the build by attaching your propellers in accordance with the image below, paying special attention to the writing on the propellers - the letter "R" after the size (e.g. 5 x 4.5R), indicates that the propeller is a ClockWise (CW) turning propeller. If you do not have an "R" after the number this means it is a CounterClockWise (CCW) turning propeller. Secure your battery in place - ready for your first flight!

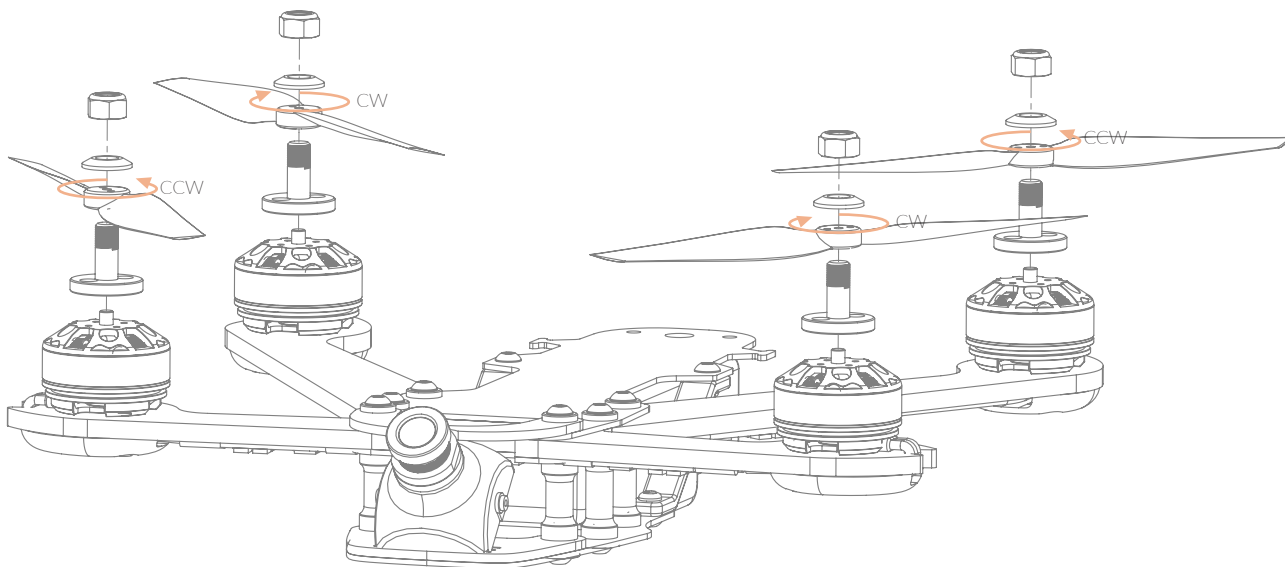

Your final setup should look like the image below, and you just need to fix your canopy in place

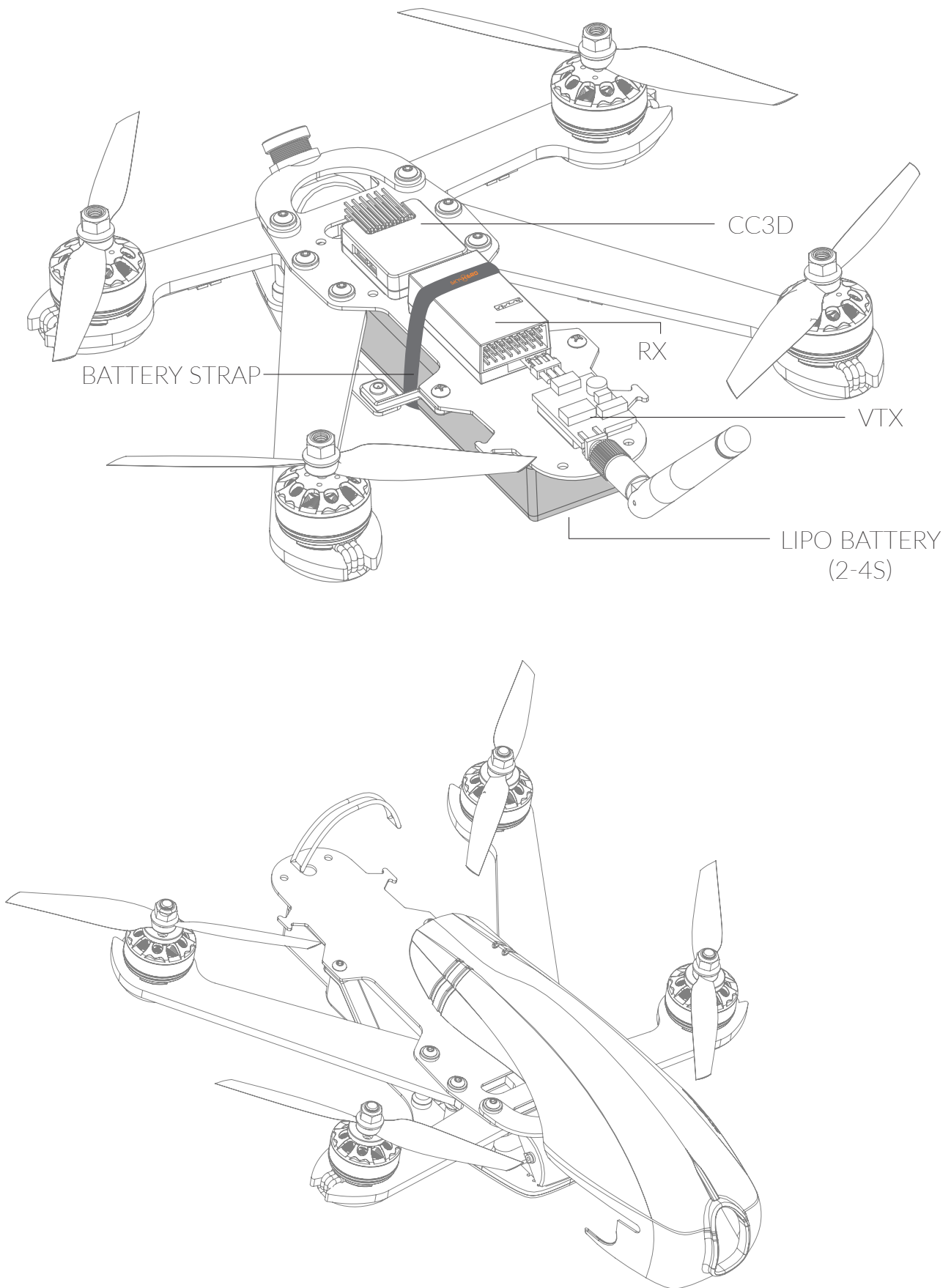

SELECTING YOUR FLIGHT MODE VIA SWITCH "C"



FLIGHT MODE (C SWITCH)

1. Stabilized Super Soft
2. Stabilized Soft
3. Rate

1. STABILIZED SUPER SOFT: (ATTITUDE MODE) Switch C in UP position

- Club Racer comes back to a level position when RIGHT STICK is back to neutral position –
- The maximum angle of the aircraft is **VERY LIMITED**.

2. STABILIZED SOFT: (ATTITUDE MODE) Switch C in MIDDLE position

- Club Racer comes back to a at position when RIGHT STICK is back to neutral position
- The maximum angle of the aircraft is **LIMITED**.

3. RATE: (RATITUDE MODE) Switch C in DOWN position

- Anakin comes back to a at position when RIGHT STICK is back to neutral position
- The maximum angle of the aircraft is **UNLIMITED**.

BEFORE YOU TAKE OFF

Refer to and follow all safety precautions mentioned in the “General Instructions and Guidelines for use” section of this manual.

Check that your aircraft is ready for flight with no loose screws or fittings (pay special attention to the propellers) insert a battery into the battery bay and use the provided strap to secure the battery in place.

Refer to and follow all safety precautions mentioned in the “Safety Advice” and “General Instructions and Guidelines for Use” sections of this manual

Make sure that your transmitter controls are all in their correct positions and that the throttle is off.

Ensure that you always turn on your transmitter before connecting the Lipo battery power. After flying make sure that once the motors have stopped turning, you always disconnect your aircraft battery before turning off your Transmitter.

MOTOR ARMING AND TAKING OFF

You arm your motors by using the sequence that you recorded during the transmitter setup stage of this manual. Make sure that the throttle control is at its lowest position and then push the other control to the Motor Arming position.

To stop the motors, you should have the throttle stick at its lowest position and you push the other stick in the opposite direction to the one you used to Arm the motors

The notes below are for a transmitter setup as Mode 2 (for Mode 1 replace “RIGHT” with “LEFT”)

[MODE 1]

LEFT STICK	RIGHT STICK

[MODE 2]

LEFT STICK	RIGHT STICK

- **Throttle:** it cannot hold the central position when released.
- **Roll:** it can return to the central position when released.
- **Pitch:** it can return to the central position when released
- **Yaw:** it can return to the central position when released.

- **Pitch:** it can return to the central position when released
- **Roll:** it can return to the central position when released.
- **Throttle:** it cannot hold the central position when released.
- **Yaw:** it can return to the central position when released.

USING ALTERNATIVE RADIOS & RECEIVERS

(not the SKY-HERO Link9)

Warning: If you decide to replace the OpenPilot software/firmware on the CC3D flight controller, you should be aware that the output port configuration (what pins are used for what) as well as the motor configuration is likely be different to the instructions in this manual and you should make sure that you have sufficient skills and knowledge to complete the configuration, as SKY-HERO offers no support if you erase the OpenPilot setup on the CC3D

SKY-HERO CC3D FLIGHT CONTROLLER IS ONLY COMPATIBLE WITH:

- S-BUS receivers
- JR & Spektrum Satellite receivers
- PPM receivers

Please note that PWM (Pulse With Modulation) is NOT SUPPORTED!

During the CC3D setup process, you will be asked to choose the receiver type from four options, please choose your receiver according to the box above, (but do not choose PWM as this is not compatible with the Anakin Club Racer ESCs) if you make the wrong choice here the receiver won't work. Click "Next" when done.

You will need to know exactly what kind of receiver you are using as different receivers require different setup steps. The Anakin Club Racer's built-in Sky-Hero CC3D supports 3 kinds of receivers:

PPM, S.BUS and DSM.

PPM (PULSE POSITION MODULATION)

A PPM signal (often referred to as a PPM stream) is basically a series of PWM signals sent one after another on the same wire. So instead of continuously sending the information for 1 channel or servo, the information for all servo's or ESCs is sent in a row on the same wire. The advantage of such a PPM signal is that only one signal wire is needed instead of all the individual wires.

For PPM receiver, the WHITE and GREY wire of the multi-coloured signal wire needs to be swapped FIRST, then connect the GREY RED BLACK plug to the PPM output of your receiver, no other wires need to be connected.

S.BUS

The S.Bus is another communication protocol from Futaba that can also be used on other radios like Taranis and Radiolink. It also combines all output channel information into single servo lead. For S.Bus receiver, use the S.Bus signal wire and connect it to the S.Bus port on the main board, there is no need to connect the multicoloured PWM/PPM signal cable from its socket.



For PPM & S.BUS
please use black, red, yellow and blue cable.
YELLOW: Not used
BLACK: Ground
RED: +5V
BLUE: Signal

DSM/SPEKTRUM/JR (SATELLITE CONNECTION)

Another receiver option is the Spektrum/JR Satellite. It allows a Spektrum/JR or satellite receiver to be connected to the CC3D.

For JR/Spektrum/DSM satellite receiver, plug the signal wire on the satellite to the DSM port on the main board. Then swap the ORANGE and BLACK wire at any end of the plug. (see explanation on next page)

DSM2/DSMX satellite receiver signal wire swap

For DSM/Spektrum/JR please use black, red, white cable.



Original DSM2/DSMX Satellite Receiver Wiring.

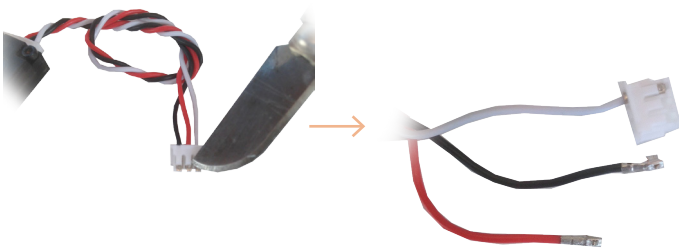

Use knife tip or similar to pull the BLACK and RED wire out of the plug and put back in reverse order.

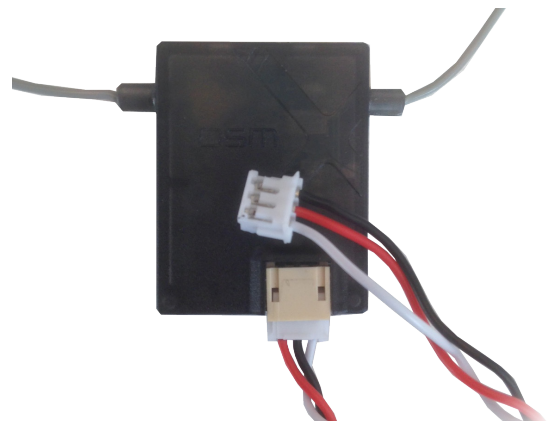

How it should look after it is completed.

Whichever Receiver you decide to use, on your Radio Transmitter you will need to assign a 3 position switch (preferably, or at least 2 position switch) to channel 5 or higher, in order to change between flight modes.

If you are using an alternative (non Sky-Hero) VTX with your Anakin Club Racer ARF model, ensure that you connect the yellow video out cable from the fpv camera, to your VTX «video in» channel.

Remember to connect the Antenna to your VTX before plugging in your battery!

NOTE: The Club Racer camera can only accept a voltage input of 5-22volts and requires 400mA.

LIMITED WARRANTY

WARRANTY AND REPAIRS

Warranty requests will be processed only with an original proof of purchase from an authorized SKY-HERO dealer, showing the name of the buyer as well as the date of purchase. If the case for Warranty is confirmed, the product will be repaired. Only SKY-HERO will be able to take the decision about repairing the product. SKY-HERO will only accept a return under warranty in case of evident product failures.

In case of paid repairs, we establish a quote that we will provide to you or to your dealer. The repairs will be carried out only after we have received confirmation from you or the dealer, regarding payment. The price of the repairs must be paid to the dealer. For chargeable repairs, we charge at least 30 minutes of work in the workshop as well as forwarding fees. In the absence of an agreement for the repairs within a period of 90 days, we reserve the option to destroy the product or use it otherwise.

WARRANTY PERIOD

Exclusive Warranty: SKY-HERO ensures the product purchased (the «Product») will be free from defects in improper materials and work-manship (subject to the terms set forth herein) in accordance with the official documentation for the applicable Warranty Period from the date of retail purchase. Warranty is governed by and construed under the laws of the country in which the original product purchase took place. The warranty period is 6 months and the duration of warranty obligation of 18 months at the expiration of the warranty period.

WARRANTY LIMITATIONS

(a) The Warranty applies only to the original purchaser and is not-transferable. The Purchaser's legal rights consists of repair or exchange under this Warranty. The Warranty applies only to products purchased from an authorized dealer of SKY-HERO product or by direct sale from SKY-HERO. Sales via third parties are not covered by this Warranty. Your Anakin Club Racer is covered by this Warranty under the specified Warranty period starting from the original purchase date. Proof of the original purchase date is required for Warranty service. SKY-HERO reserves the right to modify the provisions of this Warranty without prior notice and then revokes the existing Warranty provisions.

(b) SKY-HERO assumes no Warranty as to the merchantability of the product capabilities for any given use of the product. It is the sole responsibility of the Buyer to verify whether the product is suitable for its intended purpose.

(c) Buyer's rights: SKY-HERO will inspect the product and at its sole discretion, repair or replace it with a refurbished product or functional equivalent. These are the Buyer's exclusive legal rights of recovery where a defect is found. The decision made by SKY-HERO will be final and binding.

SKY-HERO may refuse to provide inspection, repair or replacement service for products that are out of Warranty and will charge fees if these services are provided for out-of-warranty products.

Damage or alteration of Warranty, quality or authenticity stickers, and/or product serial or electronic numbers, unauthorized repair or modification, or any physical damage to the product or evidence of opening or tampering with the product casing will also avoid this Warranty.

ATTENTION

We only carry out and cover repairs (under valid warranty) to electronic components and engines and motors. Repairs to anything else, must therefor be carried out by the purchaser themself.

DAMAGE LIMITATION

To the extent permitted by applicable law, SKY-HERO disclaims any infringement, consequential, indirect, or incidental damages, including but not limited to loss of profits, lost business investments, lost goodwill, or damages. In addition, SKY-HERO shall also not be responsible for failure of any third party equipment, even if SKY-HERO has been advised of the possibility. SKY-HERO shall not be liable for any personal injury or death or any loss or damages to property arising from the product used in a situation in which personal injury or deaths is likely occur. If you are not ready, as a buyer, to accept the liability associated with the use of the product, we ask you to return the complete product to your point of purchase, unused and in its original packaging.

QUESTIONS, ASSISTANCE AND REPAIRS

Without consulting SKY-HERO directly, your local dealer or point of sale can perform an estimate as to your eligibility for repair under our Warranty. Please, in such a case, contact your dealer who will agree with SKY-HERO of an appropriate decision, to assist you as soon as possible.

REPAIRS UNDER WARRANTY

If your product requires maintenance or repair, please contact either your dealer or SKY-HERO directly. Package the product carefully. Please note that the original packing carton does not, as a general rule, protect the product from damage that can occur during transport. Use a Parcel delivery service that provides tracking of shipment as well as sufficient carriage insurance, as SKY-HERO can accept no responsibility for the product until it has been received and signed for by one of our employees.

Please ensure that you provide a valid proof of purchase, detailed reasons for the return as well as a list of all items included within your parcel. We also need a full return mailing address together with phone number (please provide the international dialling code as necessary) and a contact e-mail address in case of questions.

WEB AND ONLINE ORDERS WARRANTY

Warranty requests will only be processed if we are able to confirm that you purchased the item direct from SKY-HERO website and if the item is still under Warranty. Only SKY-HERO will be able to take the decision about repairing the product. SKY-HERO will only accept a return under warranty in case of evident product failures.

In case of out of warranty (chargeable repairs), we provide you with a quote that you will need to accept and pay in advance. For chargeable repairs, we charge at least 30 minutes of work in the workshop as well as return shipping fees. In the absence of an agreement for the repairs within a period of 90 days, we reserve the option to destroy the product or use it otherwise, unless you agree to pay the return shipping cost.